

User manual
AIR PURIFIER IONIZER

AERO+





Thank you for choosing this product.
Please read this instruction manual before using it.

Table of Contents

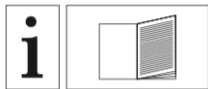
Safety Instructions	3
Product Description	4
Control Panel Description	5
Operation Instruction	6-8
Operation with Remote Control	9
Clean & Maintenance.....	10-11
AERO+ filter system	12
Specifications	13





Only for domestic use

The device is allowed to be used only for its prescribed purpose. Any other use is deemed to be a case of misuse. The user/operator and not the manufacturer will be liable for any damage or injuries of any kind resulting from such misuse.

Read the user manual before any use, refer to the corresponding section in this user manual.



Recycle unwanted materials instead of disposing of them. All appliances and packaging should be sorted and tendered at a regional recycling centre and be processed in an ecological manner.

The product conforms to the applicable European and other directives.

Safety Instructions

IMPORTANT SAFETY INSTRUCTIONS – READ CAREFULLY AND KEEP FOR FUTURE REFERENCE

- To avoid electric shock, fire or injury, please read the user manual carefully before using the appliance and keep it for future reference.
- Please use suitable power source with 230V~50Hz.
- Do not to pull or tug the power cord to switch off the appliance, otherwise it will cause fire or get an electric shock accident.
- If the supply cord is damaged, it must be replaced by the manufacturer, its service agent or similarly qualified persons in order to avoid hazard.
- Please do not insert any foreign objects into any crevices of the unit in order to avoid electric shock.
- Please keep the air inlet and the air outlet unblocked. The appliance should be used at minimum distant of 30 cm from the wall.
- Do not overload your power supply with multiple power plug, otherwise it will cause fire or get an electric shock accident.
- Forbid to put flammable and explosive objects around the machine, and do not use the appliance in an environment full of flammable gas and powder. Keep away from any fire and heat sources in order to avoid short circuit or fire.
- Keep the appliance away from direct sunlight or any heat source or any spillage area, this appliance is for indoor use only.
- With any indication of malfunction, please stop using the appliance immediately to avoid hazard or fire. Contact the authorized service center for repairing. Do not attempt to repair or change any parts by yourself.
- When the appliance is not in use for a prolonged period, please turn it off, unplug it.
- Please turn off and unplug the appliance before cleaning or maintenance.
- Please operate the appliance on firm location, to avoid accidental collision and damage to the product.
- Do not use the appliance at any spillage area. When any water spilled/dropped into the appliance, it may cause a fire or electric shock hazard
- Before using the product, please remove all the filter packaging and ensure that the filter of the product is properly installed in accordance with the manual.

Product Description

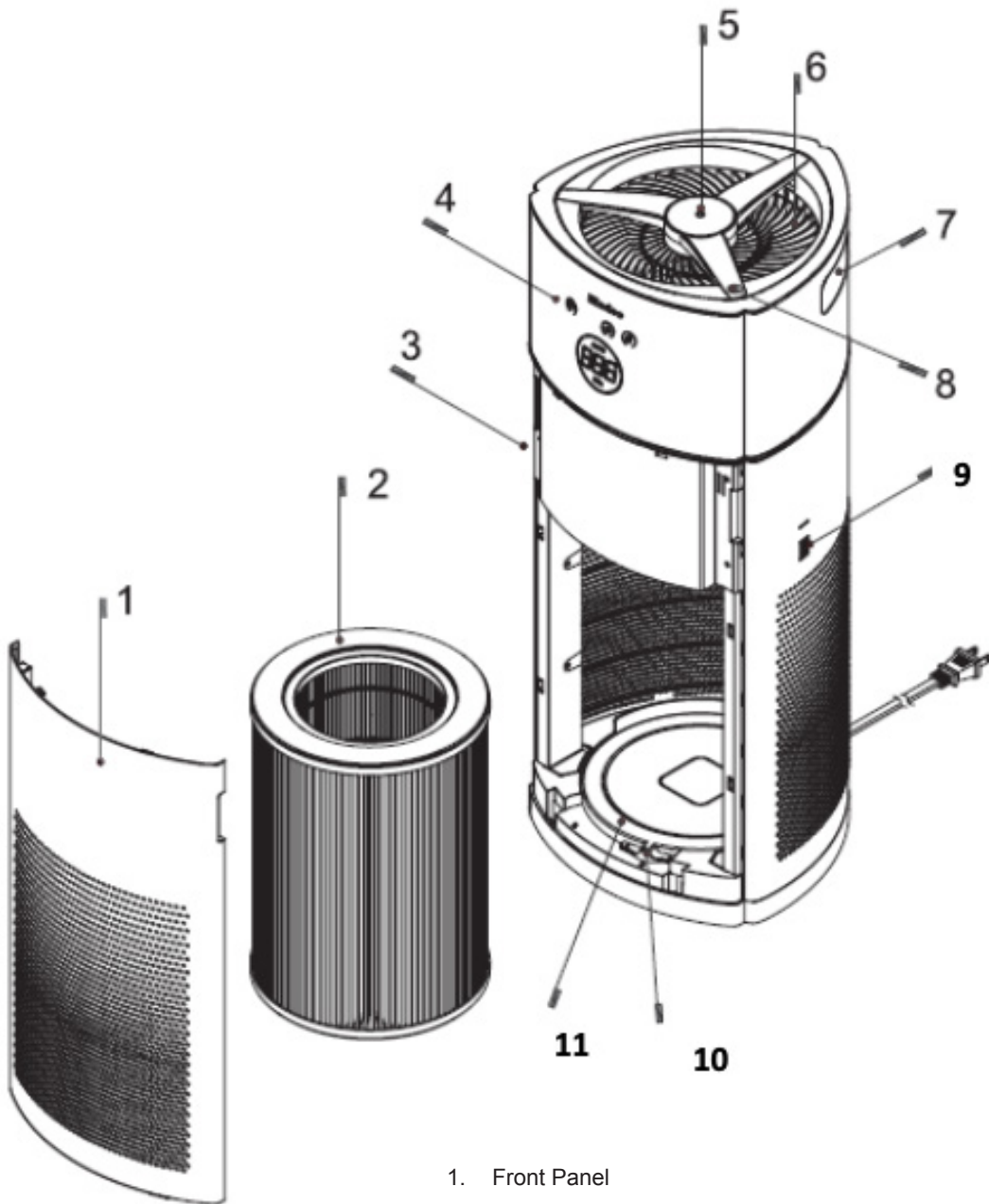

12





1. Front Panel
2. Filter
3. Dust Sensor
4. Display Indicator
5. Power ON/OFF Switch
6. Air Outlet Grille
7. Handle
8. Fan Speed Button
9. VOC Sensor
10. Filter Lock Switch
11. Filter Lifting Bracket
12. Remote Control



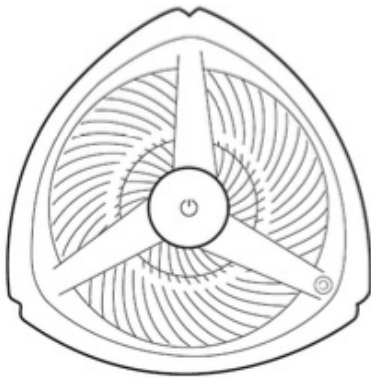





Before starting up

Remove the front cover, take the main filter out of the plastic film and insert it back into the device. Please see the steps at chapter „Filter change”.

Control Panel Description



Button	Function
	Power switch
	Fan speed button Press fan speed button for 3s to lock all buttons Press fan speed button for 10s to switch spacer scanning function
 + 	Press power button and fan speed button to reset the filter

Indicator	Function	Indicator	Function
	Timer indicator		Display of air quality (green/yellow/red)
	Negative ion indicator		Display of PM2.5 value
	Filter exchange indicator		Display of VOC Value
	Automatic mode		Quick smoke removing indicator

Operation Instructions

Note: After the power supply is connected, with a beeping sound, the appliance will enter into the standby mode. Analysis of room air quality, odour and CO2 detection, will start working.

1. Switch Function:

Press the ON/OFF button (pic.1) or wipe slowly over the power button with your hand by keeping a distance of 3-5cm (pic.2) to turn on or turn off the appliance. Every operation is accompanied by a sound.

Note: After connecting to the power supply, the appliance starts automatically a 60 seconds countdown. During this time the air cleaner is doing a one-time analysis of the air quality. After the countdown the LED display shows the current PM2.5 value and activates the negative ion function. In addition, the VOC sensor is activated after a 320 seconds countdown. Touch the power button again, the unit enters into standby mode. If you turn the appliance on again within five minutes the PM2.5 and VOC values will be shown directly.

Remark: PM2.5 and VOC values are displayed in turn every 5 seconds. (Pic.3)



Pic. 1



Pic. 2



Pic. 3

2. Filter Replacement Indicator:

The appliance features a filter replacement indicator (pic.4). After 2000 operation hours a flashing indicating light will show on the LED display which indicates that the filter needs to be changed. Please note that the operation time is rounded up to the next half hour. Example: If you have used the appliance for 40 minutes, it will be counted as 1 hour. To reset the operation time counter after exchanging the filter, press and hold the ON/OFF button as well as the FAN SPEED button for 3 seconds at the same time. The indicating light will flash 6 times during the reset and turn off.

3. Child lock function (Shared with the fan speed button)

When the air cleaner is working, press the FAN SPEED button for 3 seconds to lock all buttons on the panel and remote control. The same operation can unlock it.

Remark: Besides the power button, other functions are invalid

4. Fan Speed

Press the FAN SPEED button to select between A-1-2-3-A (automatic). The fan speed icon will display for 5 seconds (pic.5), and show the PM2.5 value.

Remark: Press the FAN SPEED button again can check the current fan speed setting.

5. Wiping Sensor

If you want to deactivate the wiping sensor (pic.2), press and hold the FAN SPEED button for 10 seconds (pic.6). To reactivate the wiping sensor, repeat the process.

6. Optical Light Sensor Function

When the appliance is in a dark environment, it will enter automatically into sleep mode after 1 minute. When the environment is bright again, the sleep mode will be deactivated after one minute.

Remark: Please note that this function can only be used when the AUTO mode is activated.



Pic. 4



Pic. 5



Pic. 6

Based on the measured PM2.5 and VOC values, you can choose a suitable fan speed by using the following tables or you can use the AUTO mode which regulates the performance level automatically:

1. PM2.5 value

PM2.5 in ug/m ³	0-75	76-150	151-500
Air quality level	Good	Medium	Bad
Fan Speed	1	2	3
Light colour	Green	Yellow	Red

VOC value

VOC in mg/m ³	0-0.60	0.60-1.00	> 1.00
Air quality level	Good	Medium	Bad
Fan Speed	1	2	3
Light colour	Green	Yellow	Red

2. When the CO2 up to 1800ppm, the yellow color light starts flashing, please open the window for ventilation.

Operation With Remote Control

Reminder: When using the remote control for the first time, install two no. 7 batteries for using.

The remote control can be used to set the same function, as on the appliance. Please note that some functions can only be controlled with the remote control. They are listed below:

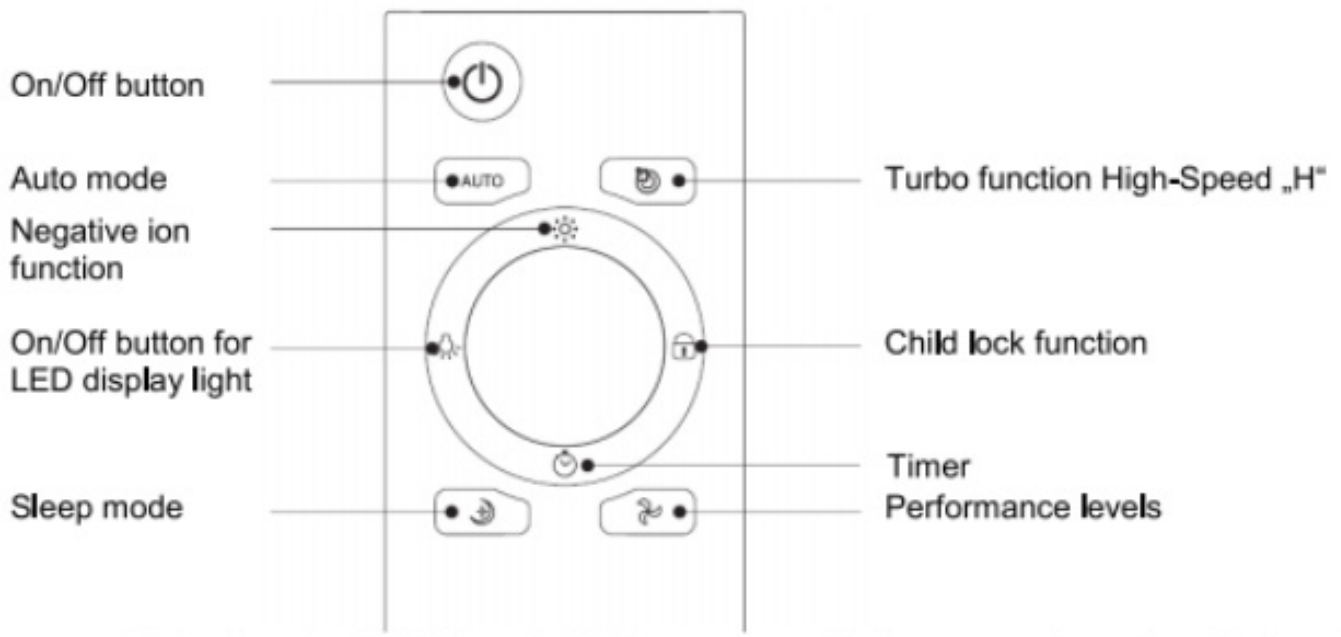

Functions controlled only with the remote control.

Turbo Function-HIGH SPEED: Please press this button to activate the turbo function. When the function is active, "H" will be shown on the display and after 5 seconds the PM2.5 value will be shown in alternation. Press the button again to deactivate the turbo function.

Negative Ion Function: When pressing this button the negative ion function can be activated and deactivated.

ON/OFF Button for LED Display Light: If the LED display light is turned off, only the ON/OFF button will be lit. When pressing this button again, all indicating lights will light up again.

Sleep Mode: During sleep mode, all sounds and lights are turned off except from the ON/OFF button. Only the ON/OFF button and the SLEEP button can be operated.

Cleaning & Maintenance

- Always disconnect the appliance from the power outlet and let it cool before cleaning. Never immerse the appliance in water to prevent electric shocks.
- Wipe over the exterior of the appliance with a soft wet cloth and then wipe dry with a dry cloth.
- Please do not use any chemicals or other abrasive cleaning agents, such as steel wool, to clean
- Depending on the pollution degree, the filter should be replaced after 6-12 months. To do so, please refer to below steps.

1. Remove the Front Panel

- a. Press the upper clasp with both hands lightly;
- b. Pull the front panel out;
- c. Lift the front panel up.

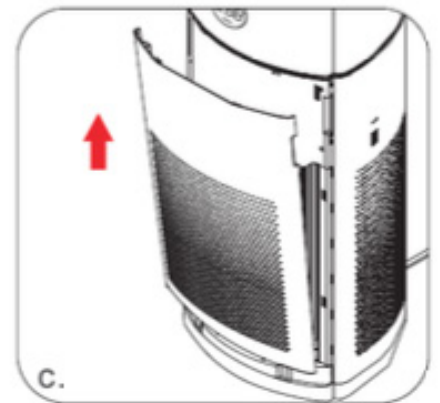
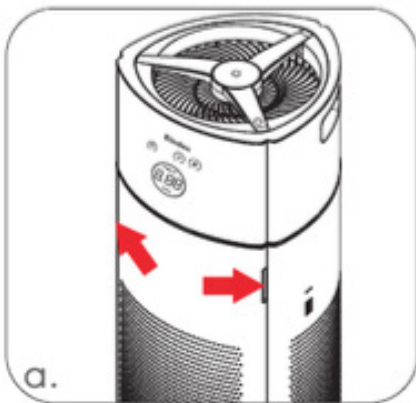

2. Replacing the old filter

- a. Drag the slide switch to slide left to remove the filter lock
- b. Take out the filter (**note**: please remove the protective film of the filter)
- c. Insert the new filter in the device
- d. Drag the slide switch to the right in order to lock filter

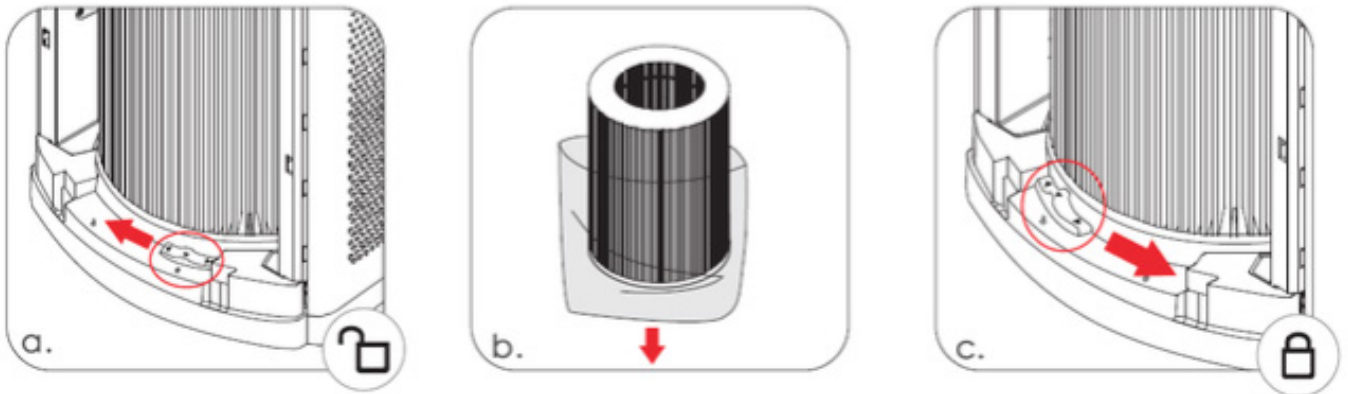

3. Install the Front Panel

- a. Insert the front panel card into the bottom slot;
- b. Gently push inward;
- c. Press gently into the chuck by aligning the latch hole.

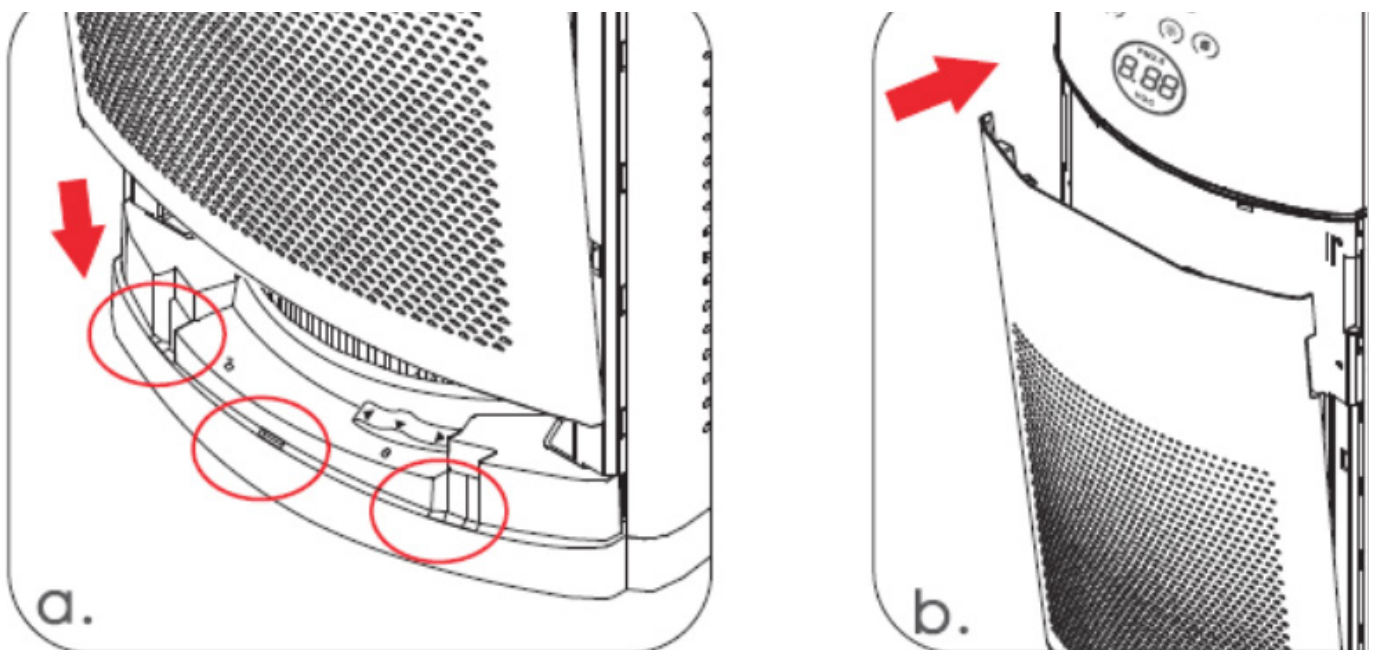

AERO+ Filter System

The AERO+ 360° filter is a premium, technologically advanced 4 in 1 filter that removes effectively 99.97% of the airborne particles, as small as 0.3 microns.

Pre-filter

The main filter has a pre-filter covering. This is a relatively wide-meshed filter that catches the coarsest particles from the air flowing through it. It captures larger airborne 20 microns particles such as dust, lint, fibers, pet hair & fur from the air that passes through the filter. The pre-filter protects and maximizes the life of the True HEPA filter.

Nanosilver

Nanosilver is woven into the pre-filter covering. Silver nanoparticles are extremely antimicrobial. When in contact with bacteria and fungus, nanosilver impacts the structural integrity of bacterial cells and inhibits cell growth.

True HEPA filter

To remove even the smallest particles, the room air flows through a HEPA filter during the cleaning process. The True HEPA filter absorbs pollen, fine dust and spores, among other things. They stick in the HEPA filter until removed or cleaned, which should be done outside.

Activated carbon filters

The activated carbon filter absorbs common household odors and toxins. The granulated activated carbon filter uses absorption, taking the contaminants into its porous and large total surface.

Ionizer

The negatively charged ions attach themselves to the smallest particles in the room air and charge them statically. The charged particles then tend to accumulate with other particles and form larger clusters, which can then be more easily absorbed by the filter medium.

Information about the sensors

Light sensor

The AERO+ is equipped with an innovative light sensor. It activates when the air purifier is use in AUTO mode. It detects when the room is dark and switches automatically to sleep mode after 1 minute approximately.

Gesture-controlled sensor

The AERO+ air purifier is equipped with a gesture controlled sensor, which makes it possible to switch the unit on and off without pressing the on/off button. Just move your hand slowly at a distance of approx. 3-4 cm above the sensor placed on the on/off switch.

PM2.5 & VOC sensors

The AERO+ sensors monitor continuously the room air quality. Optical particle sensor for PM2.5 particles (as small as 2.5 microns). VOC sensor monitors the Volatile organic compounds in the air. Finally, if the CO2 rise up to 1800ppm, the yellow colour light starts flashing.

Technical Specifications

Model	AERO+
Power Supply	AC230V~50Hz
Power Consumption	55W
[4 in 1] Filter 360°	Pre-filter, Nano-silver coating, True HEPA filter, Activated carbon filter
Ionizer	✓
CADR	500 m³/h 300CFM
Max Effective Area	60m²
Noise Level	65dB(A) at high speed
5 Fan Speed	3+Turbo+Sleep
Timer	1~24 h
PM2.5 display range	000-500ug/m³
VOC display range	0.00-9.90mg/m³
Remote Control	✓
Sensors	PM2.5 & VOC
Power Cord	1.8m
Weight	8.8 kg
Dimension	305 × 306 × 724 mm

The above technical data are for reference only. We reserve the right to modify them without notice.

Conditions of Warranty

There is a two year warranty on your air cleaner from the date of purchase.

The following applies:

- Any repairs or replacement of components during the warranty period will not result in an extension of the warranty period.
- The warranty will expire if any alterations have been made, not genuine components have been fitted or if the air cleaner has been repaired by a third party.
- Components subject to normal wear and tear, such as the air filter, are not covered by the warranty.
- The warranty is only valid on presentation of the original, unaltered, and date-stamped purchase receipt.
- The warranty does not cover damage caused by actions that deviate from those as described in the user's manual or by neglect.
- All claims for compensation, including consequential damage, will not be entertained.

Sani hellas
AIR TREATMENT

SANI HELLAS

IMPORT EXPORT TECHNICAL SA

5-7 Kosti Palama Str.

143 43 Athens, Greece

Tel. (+30) 210 3236627, 3233766

Fax (+30) 210 3247709

e-mail: info@sanihellas.gr

SANI HELLAS IMPORT EXPORT TECHNICAL SA is the sole distributor of Kullhaus products in Greece.

For further information or service please feel free to contact us.

www.sanihellas.gr - www.kullhaus.com

**Kullhaus**
BETTER AIR